

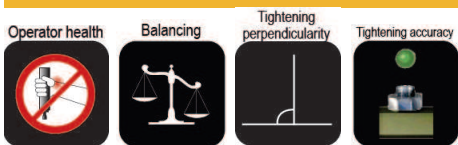

Linear Arms

BA Series



BA Series : Smooth tightening operation and perfect perpendicularity until 100 Nm.

- Erase torque reaction
- Ensure perfect perpendicularity
- Avoid illnesses
- Suppress the tiredness
- Improve the tightening quality
- Reduce the absenteeism rate
- Improve productivity

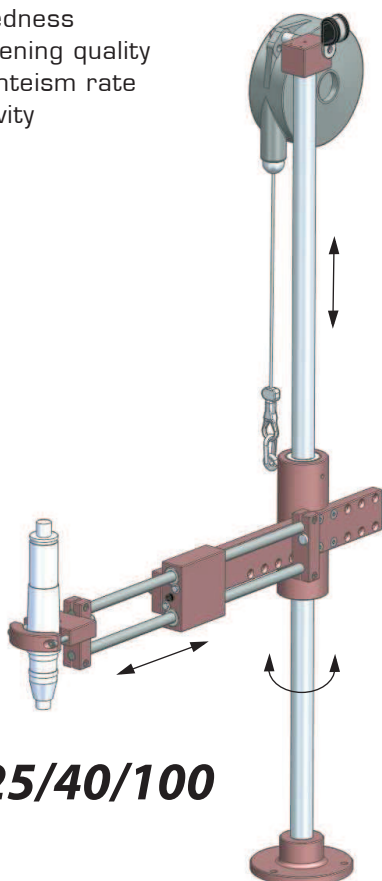

BA 5/12/25/40/100

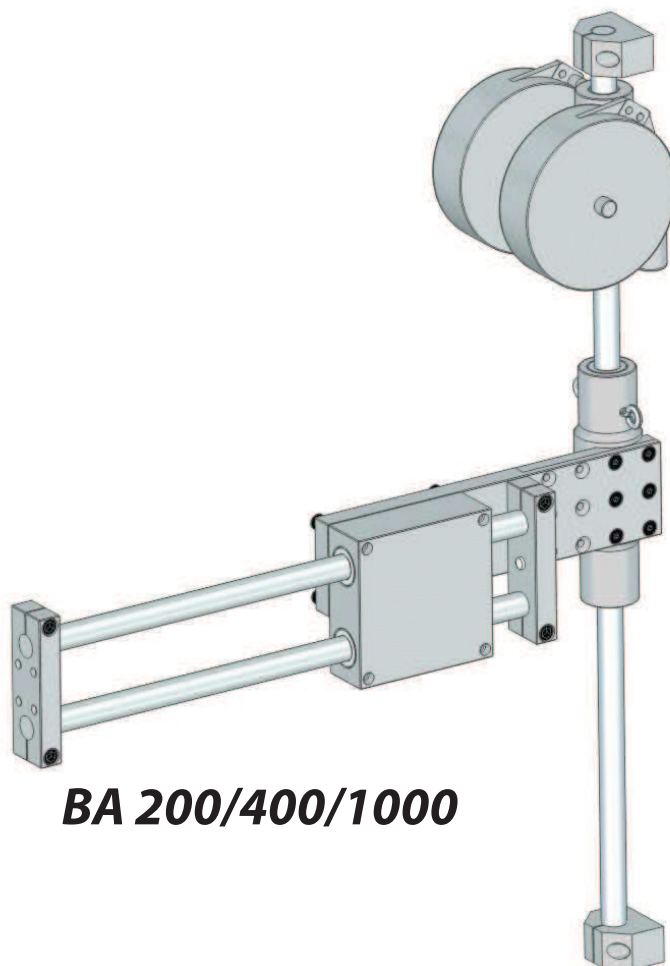

BA 200/400/1000

Model	Torque max (Nm)	Tool Ø (mm)	Stroke	Load max (kg)	Code
BA 5	5	20 - 35	200	0,9	4-1200085
BA 12	12	25 - 42	225	1,2	4-1200065
BA 25	25	28 - 52	250	2,2	4-1200076
BA 40	40	28 - 52	295	2,2/4*	4-1200067
BA 100	100	28 - 52	330	3,5/6*	4-1200068

* With additional balancer - **Code : 4-1200143** (see page 6)

Model	Torque max (Nm)	Stroke	Load max (kg)	Code
BA 200	200	345	8	4-1201092
BA 400	400	400	12	4-1201093
BA 1000	1000	400	16	4-1201094

BA 200/400/1000 are delivered without clamp, floor post and non anodized.

Linear Arms

BA...TWIN Series

BA...TWIN model is an ideal solution when two screwdrivers are used in limited space conditions.

BA... TWIN

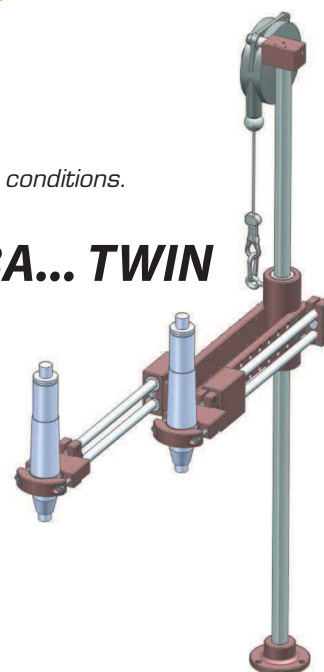

Model	Torque max (Nm)	Tool Ø (mm)	Stroke	Load max (kg)	Code
BA 12 T	12	25 - 42	225	2	4-1200823
BA 25 T	25	28 - 52	206	3	4-1200824
BA 40 T	40	28 - 52	295	4	4-1200825
BA 100 T	100	28 - 52	330	6	4-1283105

BA Accessories

Anti rotation clamp

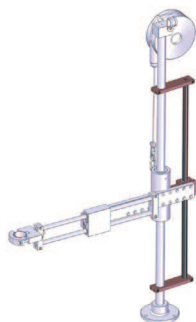

For	Code
BA 5	4-1200348
BA 12 & 25	4-1200116
BA 40 & 100	4-1200117

Extended slides

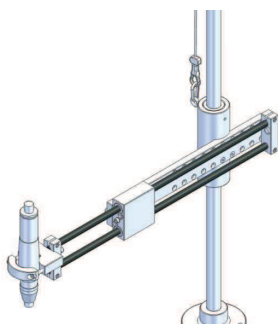

For	Stroke	Code
BA 12	+ 130	4-1200120
BA 25	+ 130	4-1200720
BA 40	+ 170	4-1200122
BA 100	+ 200	4-1200123

Double slides

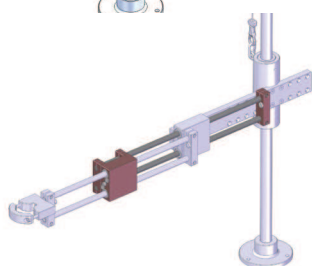

For	Stroke	Code
BA 12	+ 230	4-1200124
BA 25	+ 210	4-1200125
BA 40	+ 295	4-1200126
BA 100	+ 330	4-1200127



Linear arms

BA Accessories

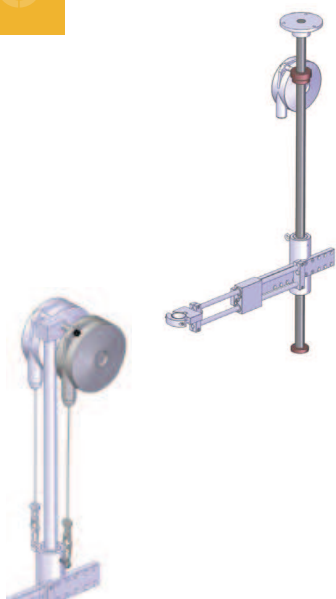

Inverse mounting kit

For	Code
BA 5	4-1200385
BA 12 & 25	4-1200128
BA 40 & 100	4-1200129

Additional balancing kit

For	Arm max load (Kg)	Code
BA 40	4	4-1200143
BA 100	6	4-1200143

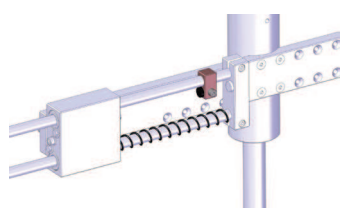

Auto rest position kit

For	Code
BA 5 & 12	4-1200118
BA 25 & 40	4-1200119

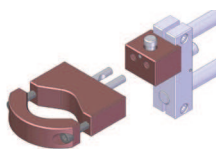

Quick change clamp

For	Adapter code	Clamp code
BA 12	4-1201109	4-1200016
BA 25	4-1201110	4-1200017
BA 40	4-1201111	4-1200017

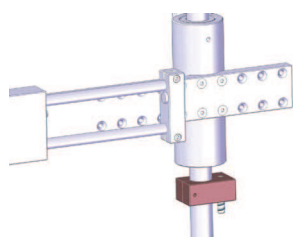

Height adjusting clamp

For	Code
BA 5	4-1200421
BA 12 & 25	4-1200422
BA 40 & 100	4-1200423

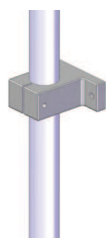

Pole upper clamp

For	Code
BA 12 & 25	4-1200130
BA 40 & 100	4-1200131



Floor post

For	Code
BA 100/200/400	4-1201096
BA 1000	4-1201097

Linear arms

BA Accessories

Downward Assistance Kits

Downward Assistance Kits will provide you with Extreme Comfort and productivity increase. Ideal for self-tapping applications it requires no effort from the operator. BAPER system features a built-in collect chuck that allows the system to be used at any height. Easy Push system operates only at a preset height by using a mechanical stop that is set along.

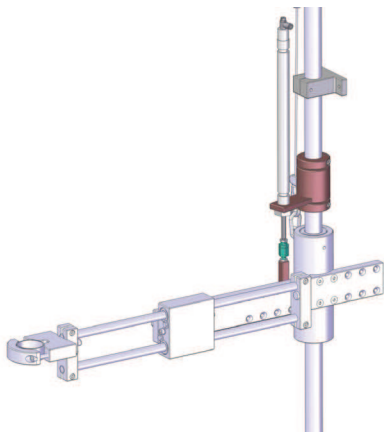

EASY PUSH

Model	For	Pushing force (Kg)	Stroke (mm)	Type	Code
EASY PUSH	BA 12	5	125	Pneumatic	4-1200099
EASY PUSH	BA 25	9	160	-	4-1200102
EASY PUSH	BA 40 & 100	9	200	-	4-1200103
EASY PUSH	BA 40 & 100	15	200	-	4-1200144
EASY PUSH	BA 100	25	200	-	4-1200145
EASY PUSH	BA 12	5	125	Electric	4-1200838
EASY PUSH	BA 25	9	160	-	4-1200839
EASY PUSH	BA 40 & 100	9	200	-	4-1200840
EASY PUSH	BA 40 & 100	15	200	-	4-1200841
EASY PUSH	BA 100	25	200	-	4-1200842
Easy Push Cable/GX					4-1200843
Easy Push Cable/DELVO					4-1200844
Cable without connector (for 5/9 kg pushing force)					4-1200845
Cable without connector (for 15/25 kg pushing force)					4-1200846
U3-D Interface for GX screwdrivers					6-1041888

EASY PUSH kits are delivered without cable.

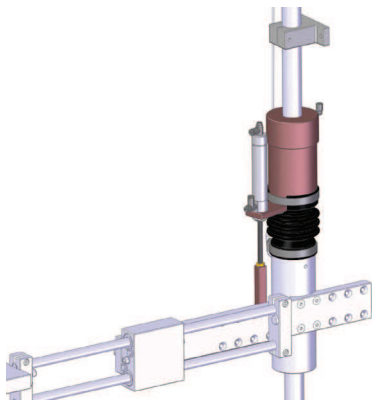

BAPER

Model	For	Pushing force (Kg)	Type	Code
BAPER	BA 12	5	Pneumatic	4-1200095
BAPER	BA 25	9	-	4-1200096
BAPER	BA 40 & 100	9	-	4-1200097
BAPER	BA 12	5	Electric	4-1200830
BAPER	BA 25	9	-	4-1200831
BAPER	BA 40 & 100	9	-	4-1200832
BAPER Cable/GX				4-1200833
BAPER Cable/DELVO				4-1200834
Cable without connector				4-1200835
U3-D Interface for GX screwdrivers				6-1041888

Electric BAPER kits are delivered without cable.

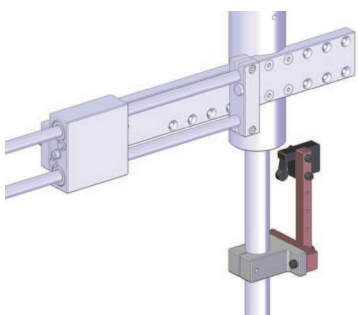

Safety kit

For	Code
BA 12 & 25	4-1200134
BA 40 & 100	4-1200135

The safety kit allows to avoid activation of downward assistance before powerbit gets in contact with the screw.



Linear arms

BA 5 to 100 Dimensions

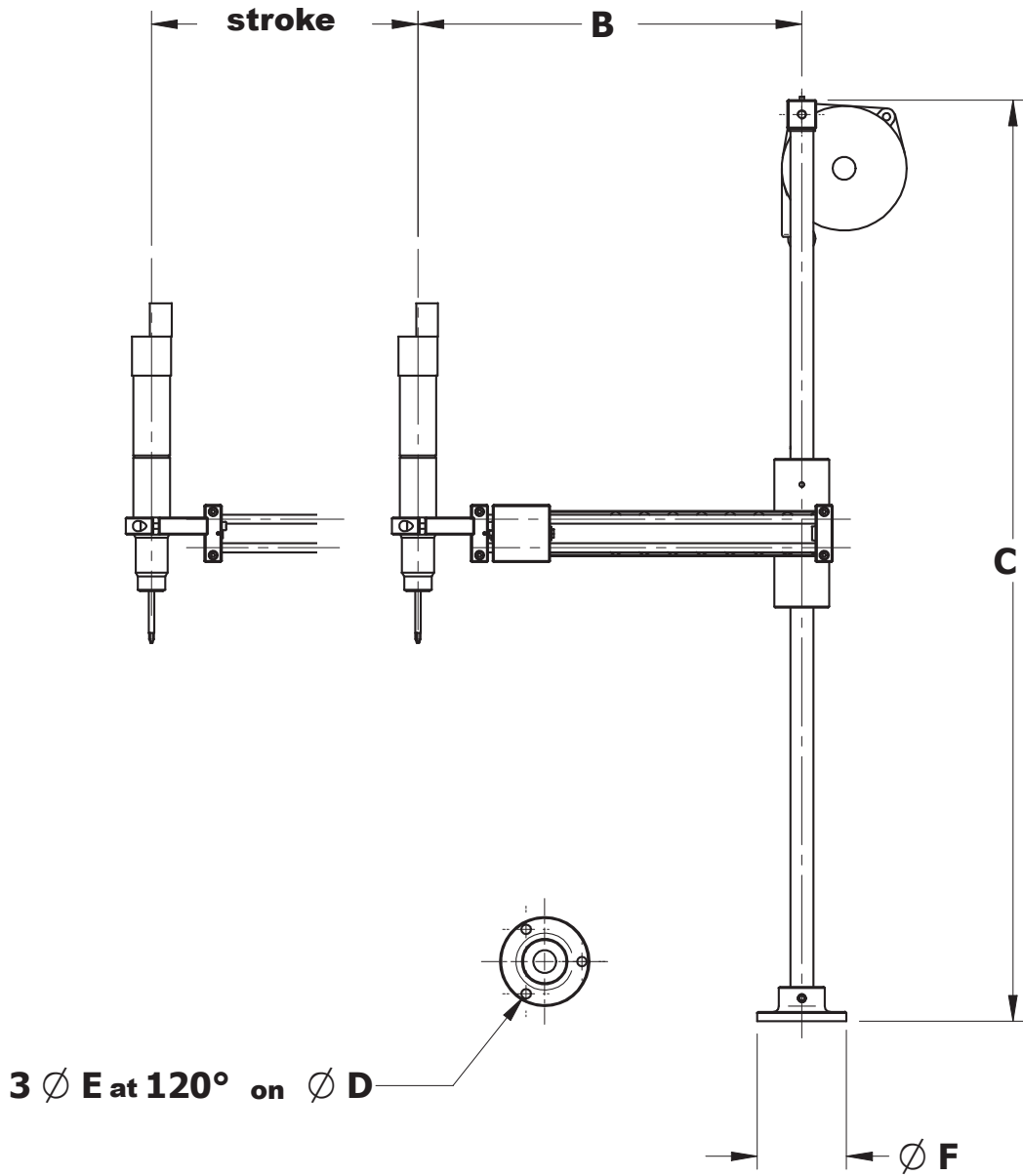

BA Dimensions

Model	Stroke A	B		C	D	E	F
		Min	Max				
BA 5	200	222	302	705	65	8,5	78
BA 12	225	186	336	805	65	8,5	78
BA 25	206	201	351	908	65	8,5	78
BA 40	295	260	460	1008	100	8,5	118
BA 100	330	315	515	1008	126	10,5	148

Linear arms

BA 200 / 400 Dimensions

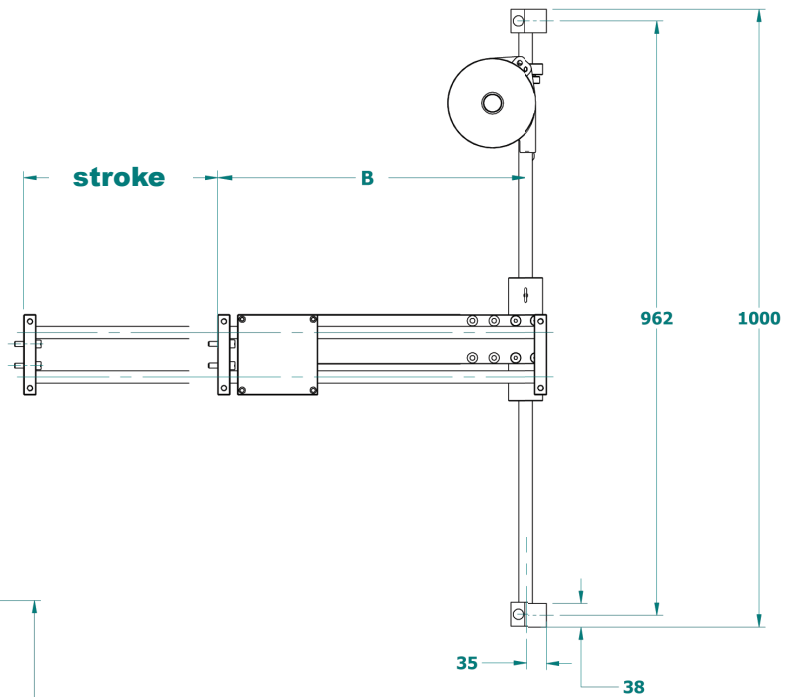

Floor post

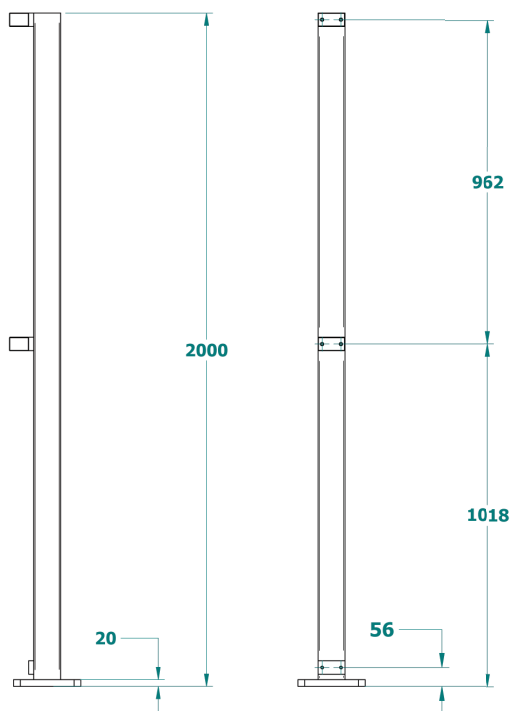

Clamp Mounting Bracket

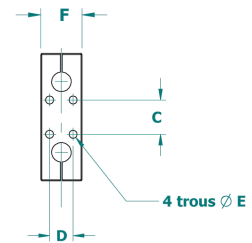

Coupling flange

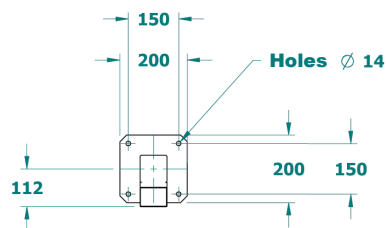
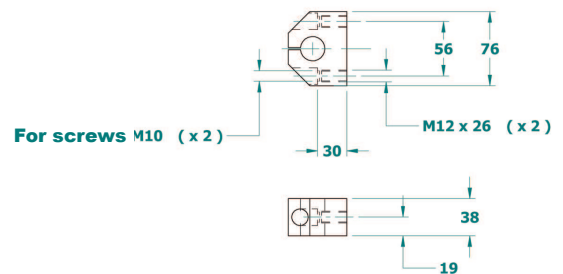

Model	Stroke A	B		C	D	E	F
		Min	Max				
BA 200	349	430	500	35	24	8,2	42
BA 400	390	326	406	40	28	12,2	52